











|   |                       |    |
|---|-----------------------|----|
|   | <b>PERCHÉ/WHY</b>     | 01 |
|   | <b>CHI/WHO</b>        | 02 |
|    | <b>98 L</b>           | 04 |
|    | <b>90 STD</b>         | 06 |
|   | <b>90 BLOCK</b>       | 08 |
|    | <b>80 STD</b>         | 10 |
|   | <b>80 CAVO/CABLE</b>  | 12 |
|    | <b>70 STD</b>         | 14 |
|   | <b>70 BLOCK</b>       | 16 |
|    | <b>65 STD</b>         | 18 |
|   | <b>65 CC/SN</b>       | 20 |
|   | <b>65 ECO</b>         | 22 |
|    | <b>81 P</b>           | 24 |
|  | <b>80 R</b>           | 26 |
|   | <b>88 E</b>           |    |
|   | <b>145 E</b>          |    |
|  | <b>187 T</b>          | 30 |
|  | <b>85 F</b>           | 32 |
|   | <b>COLORI</b>         | 34 |
|   | COLOURS               |    |
|   | <b>DIMENSIONI</b>     | 35 |
|   | DIMENSIONS            |    |
|   | <b>IMPACETTAMENTI</b> | 36 |
|   | PACK-UP SYSTEMS       |    |



# FRANGISOLE, PERCHÉ?

## VERSATILE

Ideale per ogni  
tipologia di edificio

## EFFICACE

Evita noiosi  
abbagliamenti  
e fastidiosi  
surriscaldamenti

## BIO-CLIMATICO

Ottimizza le relazioni  
energetiche con  
l'ambiente naturale  
circostante

## VANTAGGIOSO

Consente un  
risparmio sul  
consumo energetico

# WHY SUN PROTECTION BLINDS?

## VERSATILE

Suitable and excellent  
for any building type

## EFFECTIVE

Avoid bothersome  
dazzling and  
overheating

## BIO-CLIMATIC

Upgrade the  
environmental  
energetic exchange

## PROFITABLE

Reduce power  
consumption





# LUPAK METAL®

Dall'esperienza Mengozzi e Mazzoni nasce LUPAK METAL srl. LUPAK METAL, marchio già conosciuto ed affermato nel settore dei sistemi frangisole, dopo circa dieci anni di produzione e vendita diretta in Italia e all'estero, è ora una realtà indipendente.

From the Mengozzi and Mazzoni experience, born LUPAK METAL Ltd. LUPAK METAL, already well known brand in the field of sun blind systems, after ten years production and direct sales in Italy and abroad, is now an independent Company.



La gamma dei prodotti LUPAK METAL soddisfa ogni esigenza in tema di schermatura solare, integrandosi con i moderni sistemi di gestione domotica. Inoltre rappresenta la soluzione ideale per l'isolamento termico e la corretta regolazione della luce naturale negli ambienti. I sistemi frangisole LUPAK METAL sono i preferiti nelle costruzioni ad altissima prestazione energetica. Perciò LUPAK METAL è oggi partner di PASSIVHAUS per lo sviluppo del concetto di edifici ad "energia quasi zero".

The range of LUPAK METAL products meets all requirements in terms of solar shading, integrating with modern home automation systems. It also represents the ideal solution for thermal insulation and proper regulation of natural light in the rooms. The LUPAK METAL sun blind systems are the preferred for high energy performance in buildings. Therefore LUPAK METAL is now PASSIVHAUS partner for the development of the concept of "nearly zero energy" buildings.

LUPAK METAL vuol dire minori consumi per un maggior rendimento energetico nel rispetto dell'ambiente.

LUPAK METAL means lower consumption for improved energy efficiency while respecting the environment.





- Lame in alluminio, larghezza 96 mm, profilate e dotate di gommino inferiore antirumore
- Cassonetto in acciaio inox
- Nessun terilene o texband tra le lame
- Meccanismo di trazione a catena
- Orientamento delle lame eseguito attraverso un robusto meccanismo di pantografi in acciaio inossidabile
- Trasmissione a catena in acciaio nichelato integrato all'interno delle guide
- Guide laterali in alluminio anodizzato verniciate a polvere, dotate di guarnizione per un migliore scorrimento ed una efficace riduzione del rumore
- Orientamento delle lame in posizione abbassata
- Sistema di frizione automatica che previene i danni dovuti al contatto con oggetti
- Maggiore resistenza alle effrazioni
- Eccellente resistenza al vento CLASSE 7
- Argano in luce esterna completo di asta di manovra
- Motore voltaggio 230V/50 Hz con spina Hirschmann

- Aluminium roll formed slats, 96mm width, with rubber profile to avoid noise
- Stainless steel head-box
- No tilting ladder tape between the slats
- Traction chain system
- Slat tilting got by heavy duty pantograph in stainless steel
- Nickel plated steel chain inside the side rail guides
- Aluminium painted side rail guides with rubber profile
- Slat tilting in low position
- Automatic friction system to avoid harming in case of obstacle
- Burglar protection system, even stronger
- Wind resistance CLASS 7
- Bevel gear winch option, with working rod
- Motor option 230V/50Hz with Hirschmann connection

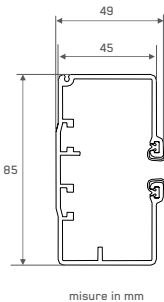
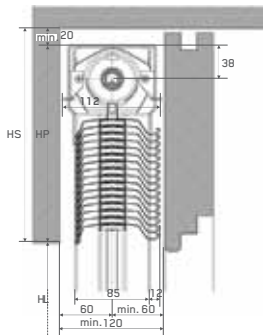







- Adatta per grandi luci, oscuramento al 90%
- Design accattivante della lama
- Frangisole orientabile in ogni posizione
- Movimento delle lame a 90°

- Suitable for big clearing openings, 90% darkening
- Slat eye-catching design
- Slats tilting in every position
- 90° slat movement

LUPAK  
METAL

90

STD





LUPAK  
METAL

90

BLOCK



- Adatta per grandi luci, oscuramento al 90%
- Design accattivante della lama
- Frangisole orientabile in ogni posizione
- Movimento delle lame a 90°
- Sistema antisollevamento

- Suitable for big clearing openings, 90% darkening
- Slat eye-catching design
- Slats tilting in every position
- 90° slat movement
- Anti-lifting system





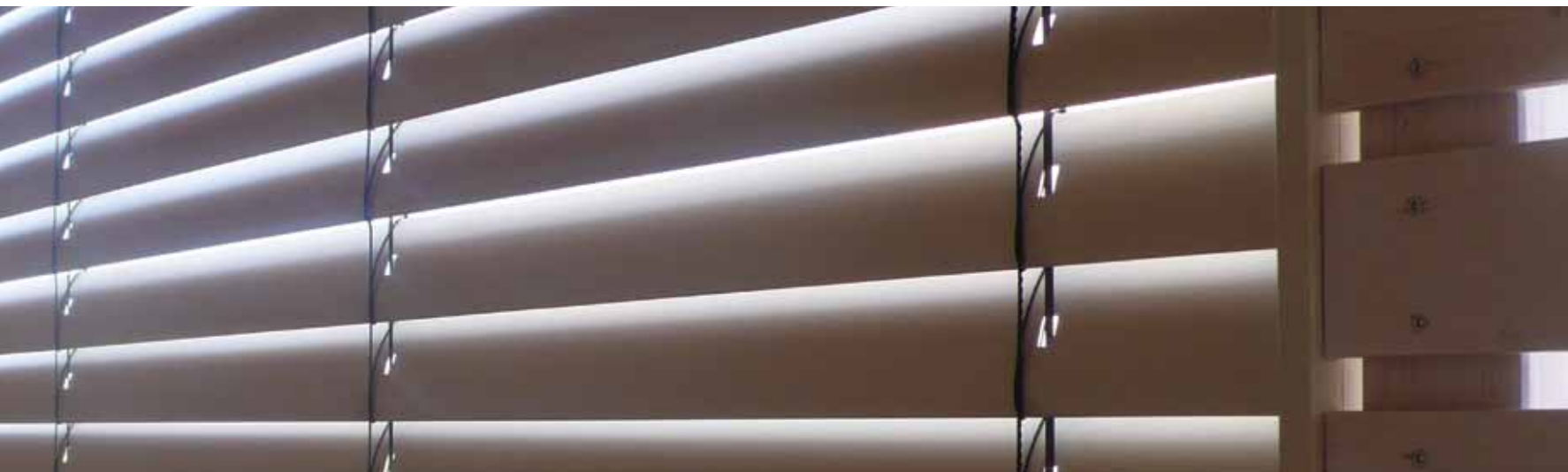

- Adatta per grandi luci
- Gradevole impatto estetico
- Frangisole orientabile in ogni posizione
- Movimento delle lame a 180°

- Suitable for large clear openings
- Pleasing aesthetic impact
- Slats tilting in every position
- 180° slat movement





LUPAK  
METAL

80

CAVO / CABLE



- Adatta per facciate in doppia pelle
- Impatto estetico moderno
- Frangisole orientabile in ogni posizione
- Movimento delle lame a 180°

- Suitable for double-layered fronts
- Modern aesthetic impact
- Slats tilting in every position
- 180° slat movement







- Adatta per montaggi in spazi limitati
- Oscuramento al 90%
- Design accattivante della lama
- Frangisole orientabile su ogni posizione
- Movimento delle lame a 90°



- Suitable for assembly in limited spaces
- 90% darkening
- Catchy design of the slat
- Slats adjustable in every position
- 90° slat movement



- Adatta per montaggi in spazi limitati
- Oscuramento al 90%
- Sistema antisollevamento
- Frangisole orientabile in ogni posizione
- Movimento delle lame a 90°

- Suitable for assembly in limited spaces
- 90% darkening
- Anti-lifting system
- Slats adjustable in every position
- 90° slat movement





- Adatta per montaggi in spazi limitati
- Gradevole impatto estetico
- Frangisole orientabile in ogni posizione
- Movimento delle lame a 180°

- Suitable for assembly in limited spaces.
- Pleasing aesthetic impact
- Slats tilting in every position
- 180° slat movement





- Per montaggi in spazi limitati; non necessita della veletta di copertura
- Gradevole impatto estetico
- Frangisole orientabile in ogni posizione
- Movimento delle lame a 180°

- Suitable for assembly in limited spaces; no need of covering profile
- Pleasing aesthetic impact
- Slats tilting in every position
- 180°slat movement



- Adatta per montaggi in spazi limitati e soluzioni economiche
- Gradevole impatto estetico
- Frangisole orientabile in ogni posizione
- Movimento delle lame a 180°

- Suitable for assembly in limited spaces and inexpensive solutions.
- Pleasing aesthetic impact.
- Slats tilting in every position.
- 180° slat movement







LUPAK  
METAL

65

ECO



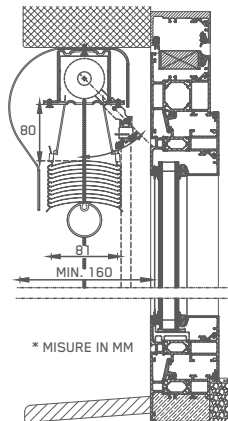

- Lame in alluminio, larghezza 81 mm, spessore 0,45 mm
  - Cassonetto in acciaio zincato di dimensioni 56x58 mm spess.0,6 in tinta alle lamelle
  - Terminale in alluminio estruso  $\varnothing$  42mm in tinta RAL con la tenda
  - Guide cavo in acciaio  $\varnothing$  3 mm completo di ancoraggio di tensionamento
  - Argano in luce esterna completo di asta di manovra
  - Motore voltaggio 230V/50 Hz con spina Hirschmann
- 
- Aluminium roll formed slats: 81mm width - 0,45 mm thickness
  - Galvanized steel head-box: 56x58mm - 0,6mm thickness. Painted
  - Aluminium extruded bottom bar  $\varnothing$ 42mm, painted
  - Steel guide ropes  $\varnothing$ 3mm with drawing anchoring system
  - Bevel gear winch in outdoor clear opening, with working rod
  - Motor 230V/50Hz with Hirschmann connection



LUPAK  
METAL

81 P



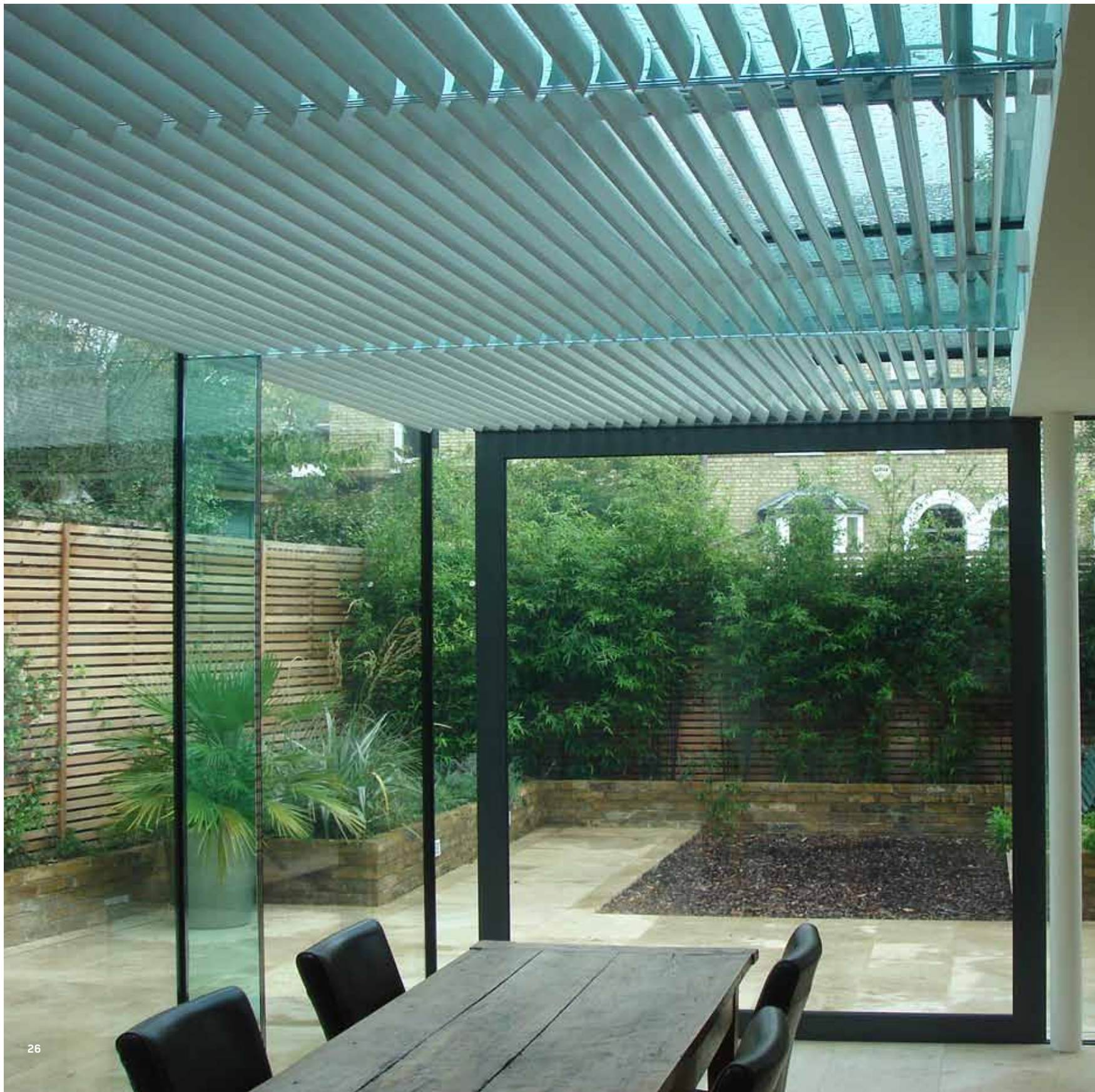



## 80 R

E' una frangisole orientabile, elegante ed efficiente in grado di proteggere dal sole.

La si può applicare sia internamente che esternamente. Si possono effettuare svariate realizzazioni moderne ed accattivanti da installare su, vetrate in verticale fisse, verande , terrazze , etc.

### 80 R orientabile

- Lamelle in lega di alluminio da 80 mm, termo laccata con vernice antigraffio su ambo i lati
- Orientamento da 0° a 95°
- Schermatura dal sole con montaggio sia verticale sia orizzontale
- Comando ad argano con asta o a motore
- Possibilità di realizzare più moduli anche di forma irregolare
- Di facile installazione

## 88 E

E' una frangisole orientabile, elegante ed efficace in grado di proteggere dal sole e dalla pioggia. La si può applicare sia internamente che esternamente.

Si possono effettuare svariate realizzazioni moderne ed accattivanti da installare su, vetrate in verticale fisse , verande , terrazze , pergolati, gazebo, etc.

### 88 E orientabile

- Lama in alluminio estruso da 88 mm
- Orientamento da 0° a 95°
- Schermatura dal sole e pioggia in maniera verticale ed orizzontale (grado di pendenza minimo 15° per pioggia).
- Comando ad argano con asta o a motore
- Possibilità di realizzare più moduli anche di forma irregolare
- Di facile installazione

## 145 E

E' una frangisole orientabile, elegante ed efficiente in grado di proteggere dal sole.

La si può applicare sia internamente che esternamente. Si possono effettuare svariate realizzazioni moderne ed accattivanti da installare su, vetrate in verticale fisse , verande , terrazze , pergolati, gazebo, etc.

### 145 E orientabile

- Lama in alluminio estruso da 145 mm
- Orientamento da 0° a 95°
- Schermatura dal sole con montaggio sia verticale che orizzontale
- Comando ad argano con asta o a motore
- Possibilità di realizzare più moduli anche di forma irregolare
- Di facile installazione

LUPAK  
METAL

80 R

88 E

145 E



## 80 R

It's a tilting, smart and effective sunblind able to protect from the sun. It can be mounted both internally and externally. A variety of modern and eye-catching solutions is available for installation on: fixed vertical windows, verandas, terraces, etc.

### 80 R mobile louver

- Aluminum alloy 80 mm slat, thermo-lacquered with anti-scratch paint on both sides
- Tilting from 0° to 95°
- Sun screening with both vertical and horizontal assembly
- Winch operated by rod or motor driven
- Possibility to realise more units also in irregular forms
- Easy installation



## 88 E

It's a tilting, smart and effective sunblind, able to protect from sun and rain. It can be mounted both internally and externally. A variety of modern and eye-catching solutions is available for installation on: fixed vertical windows, verandas, terraces, pergolas, gazebos, etc.

### 88 E mobile louver

- Extruded aluminium 88 mm slats
- Tilting from 0° to 95°
- Protection from sun and rain both in vertical and horizontal position (15° minimum inclination degree for rain)
- Winch operated by rod or motor driven
- Possibility to realise more units also in irregular forms
- Easy installation



## 145 E

It's a tilting, smart and effective sunblind, able to protect from sun. It's applicable both internally and externally. A variety of modern and eye-catching solutions is available for installation on: fixed vertical windows, verandas, terraces, pergolas, gazebos, etc.

### 145 E mobile louver

- Extruded aluminium 145 mm slats
- Tilting from 0° to 95°
- Protection from sun and rain both in vertical and horizontal position
- Winch operated by rod or motor driven
- Possibility to realise more units also in irregular forms
- Easy installation



LUPAK  
METAL



80 R



88 E



145 E





187 T è un sistema di protezione solare a pale regolabili che può essere installato sia in posizione verticale che orizzontale

- Questo sistema consente l'orientamento delle pale a 150°
- Le pale contribuiscono al flusso d'aria, evitando così l'effetto serra
- Il prodotto resiste al vento, alla neve ed alla pioggia.
- L'inclinazione minima è di 8 mm al mt. per permette lo scolo dell'acqua
- Dimensioni standard o su misura per una superficie massima di 15 mq per modulo
- La lunghezza dipende dal numero di pale fino ad un massimo di 6 m, mentre in larghezza si raggiungono i 3 m
- Possibilità di inserire dei pluviali interni nella struttura in alluminio
- Movimentazione disponibile ad argano o a motore
- Struttura in alluminio termo-laccato
- Pale, supporti e grondaie in alluminio termo-laccato
- Accessori di fissaggio in materiale inossidabile



187 T is a sun screen system with tilting wings, suitable either for vertical and horizontal installation

- Tilting wings system up to 150°
- Air ventilation to avoid greenhouse effect
- High resistance to wind, snow and rain
- Minimum slope for water draining: 8mm/m
- Dimension on request, up to 15m<sup>2</sup> max. surface
- Length up to 6m / Width up to 3m
- Possibility to add inner draining profiles
- Available with motor or gear working
- Aluminium painted frame
- Aluminium wings, supports, and profiles
- Stainless steel fastening accessories

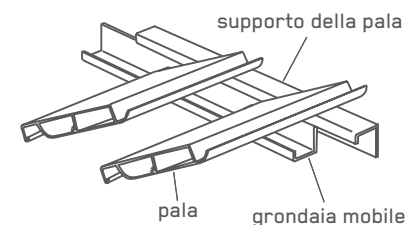
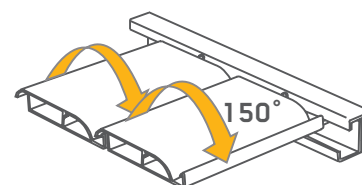



85 F è un sistema di protezione solare a lame fisse, particolarmente indicata per ricoprire e riqualificare facciate di edifici industriali

- Le lame sono inclinate fisse a 30° o a 45°
- Possibilità di schermare la luce del sole mantenendo la corretta areazione
- Di facile installazione
- I materiali utilizzati non richiedono manutenzione straordinaria
- Frangisole disponibile in alluminio con spessore variabile da 0,50 mm a 1 mm in base alla lunghezza ed alla esposizione al vento
- Lame con larghezze variabili
- Guide in acciaio o di colore preverniciato marrone scuro







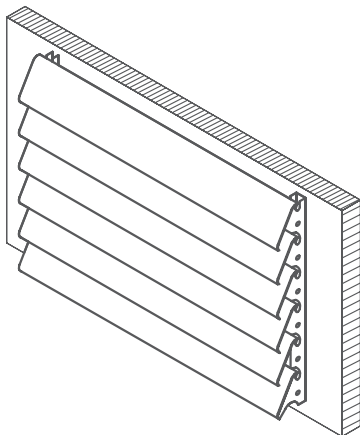







85 F is a fixed louver, particularly suitable for industrial factory building front

- Sloping slats: 30° or 45°
- Sun screen protection while right ventilation
- Easy to fit up
- No extraordinary maintenance needed
- Aluminium slats available with thickness range from 0,5 to 1,0mm, it depends on length and wind exposure
- Cut measure width
- Steel support, brown painted on request



# COLORI COLOURS

| MODELLO<br>ITEM  |   | 98 L | 90 STD<br>90 BLOCK | 80 STD<br>80 CAVO<br>/CABLE | 70 STD<br>70 BLOCK | 65 STD<br>65 CC/SN<br>65 ECO | 81 P | 80 R | 88 E | 145 E | 187 T | 85 F |
|--|---|------|--------------------|-----------------------------|--------------------|------------------------------|------|------|------|-------|-------|------|
| <b>BIANCO</b><br>WHITE                                   |    | ■    | ■                  | ■                           | ■                  | ■                            | ■    | ■    | ■    | ■     | ■     | ■    |
| <b>FIORE DI VANIGLIA</b><br>VANILLA FLOWER<br>RAL 1013   |    | ■    | ■                  | ■                           | ■                  | ■                            | ■    | ■    | ■    | ■     | ■     | ■    |
| <b>VERDE PRIMAVERA</b><br>SPRING GREEN<br>RAL 6021       |    | ■    | ■                  | ■                           | ■                  | ■                            | ■    | ■    | ■    | ■     | ■     | ■    |
| <b>VERDE FORESTA</b><br>FOREST GREEN<br>RAL 6005         |    | ■    | ■                  | ■                           | ■                  | ■                            | ■    | ■    | ■    | ■     | ■     | ■    |
| <b>MARRONE CAFFÈ</b><br>COFFEE BROWN<br>RAL 8017         |    | ■    | ■                  | ■                           | ■                  | ■                            | ■    | ■    | ■    | ■     | ■     | ■    |
| <b>GRIGIO GHIACCIO</b><br>GREY ICE<br>RAL 7035           |    | ■    | ■                  | ■                           | ■                  | ■                            | ■    | ■    | ■    | ■     | ■     | ■    |
| <b>METAL</b><br>METAL<br>RAL 9006                        |   | ■    | ■                  | ■                           | ■                  | ■                            | ■    | ■    | ■    | ■     | ■     | ■    |
| <b>METAL TRAFORATO</b><br>PIERCED METAL<br>RAL 9006      |  | ■    | ■                  | ■                           | ■                  | ■                            | ■    | ■    | ■    | ■     | ■     | ■    |
| <b>TITANIO</b><br>TITANIUM<br>RAL 9007                   |  | ■    | ■                  | ■                           | ■                  | ■                            | ■    | ■    | ■    | ■     | ■     | ■    |
| <b>TITANIO TRAFORATO</b><br>PIERCED TITANIUM<br>RAL 9007 |  | ■    | ■                  | ■                           | ■                  | ■                            | ■    | ■    | ■    | ■     | ■     | ■    |
| <b>GRIGIO FOSSILE</b><br>FOSSIL GREY<br>RAL 7016         |  | ■    | ■                  | ■                           | ■                  | ■                            | ■    | ■    | ■    | ■     | ■     | ■    |
| <b>ROSSO RUBINO</b><br>RUBY RED<br>RAL 3003              |  | ■    | ■                  | ■                           | ■                  | ■                            | ■    | ■    | ■    | ■     | ■     | ■    |
| <b>NATURAL ANODIZZATO</b><br>NATURAL ANODIZED            |  | ■    | ■                  | ■                           | ■                  | ■                            | ■    | ■    | ■    | ■     | ■     | ■    |

**COLORI AGGIUNTIVI SOLO PER IL MODELLO 98L / ADDITIONAL COLOURS AVAILABLE ONLY FOR 98L MODEL:** VSR 010 BIANCO/SIGNAL WHITE, VSR 906 BLU OLTREMARE/ULTRAMARINE BLUE, VSR 440 BLU AZZURRO/AZURE BLUE, VSR 903 BLU COLOMBA/PIGEON BLUE, VSR 908 BLU TURCHESE/TURQUOISE BLUE, VSR 120 TERRACOTTA/TOMATO RED, VSR 720 GIALLO CROMO/DAFFODIL YELLOW, VSR 110 BEIGE/BEIGE, VSR 240 BEIGE CHIARO/LIGHT BEIGE, VSR 909 BEIGE VERDASTRO/GREEN BEIGE, VSR 780 BRONZO CHIARO/LIGHT BRONZE, VSR 130 GRIGIO/AGATE GREY, RAL 7022 GRIGIO OMBRA/UMBRA GREY, RAL 9005 NERO INTENSO/JET BLACK



# IMPACCHETTAMENTI PACK-UP SYSTEMS

98 L

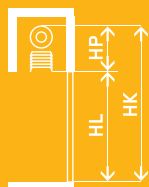

|       |      |      |      |      |      |      |      |      |      |      |      |      |      |      |      |      |      |      |      |      |
|-------|------|------|------|------|------|------|------|------|------|------|------|------|------|------|------|------|------|------|------|------|
| HP mm | 257  | 269  | 282  | 295  | 308  | 320  | 333  | 346  | 358  | 371  | 384  | 396  | 409  | 422  | 435  | 447  | 460  | 473  | 486  | 499  |
| HL mm | 500  | 1460 | 1630 | 1710 | 1880 | 2050 | 2140 | 2310 | 2390 | 2560 | 2730 | 2810 | 2980 | 3060 | 3230 | 3400 | 3490 | 3660 | 3830 | 3920 |
|       | 1450 | 1620 | 1700 | 1870 | 2040 | 2130 | 2300 | 2380 | 2550 | 2720 | 2800 | 2970 | 3050 | 3220 | 3390 | 3480 | 3650 | 3820 | 3910 | 4000 |
| HK mm | 757  | 1729 | 1912 | 2005 | 2188 | 2370 | 2473 | 2656 | 2748 | 2931 | 3114 | 3206 | 3389 | 3482 | 3665 | 3847 | 3950 | 4133 | 4316 | 4419 |
|       | 1707 | 1889 | 1982 | 2165 | 2348 | 2450 | 2633 | 2726 | 2908 | 3091 | 3184 | 3366 | 3459 | 3642 | 3825 | 3927 | 4110 | 4293 | 4396 | 4499 |

90 STD  
90 BLOCK

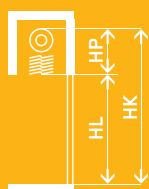

|       |      |      |      |      |      |      |      |      |      |      |      |      |      |      |      |
|-------|------|------|------|------|------|------|------|------|------|------|------|------|------|------|------|
| HP mm | 170  | 180  | 200  | 210  | 220  | 240  | 260  | 280  | 290  | 310  | 320  | 340  | 350  | 370  | 380  |
| HL mm | 830  | 1071 | 1301 | 1541 | 1781 | 2011 | 2241 | 2471 | 2711 | 2941 | 3181 | 3411 | 3651 | 3881 | 4121 |
|       | 1080 | 1320 | 1550 | 1790 | 2030 | 2260 | 2490 | 2720 | 2960 | 3190 | 3430 | 3660 | 3900 | 4130 | 4370 |
| HK mm | 1000 | 1251 | 1501 | 1751 | 2001 | 2251 | 2501 | 2751 | 3001 | 3251 | 3501 | 3751 | 4001 | 4251 | 4501 |
|       | 1250 | 1500 | 1750 | 2000 | 2250 | 2500 | 2750 | 3000 | 3250 | 3500 | 3750 | 4000 | 4250 | 4500 | 4750 |

80 STD  
80 CAVO  
/CABLE

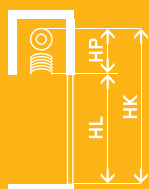

|       |      |      |      |      |      |      |      |      |      |      |      |      |      |      |
|-------|------|------|------|------|------|------|------|------|------|------|------|------|------|------|
| HP mm | 170  | 190  | 210  | 230  | 250  | 270  | 280  | 300  | 320  | 340  | 360  | 380  | 390  | 410  |
| HL mm | 830  | 1061 | 1291 | 1521 | 1751 | 1981 | 2221 | 2451 | 2681 | 2911 | 3141 | 3371 | 3611 | 3841 |
|       | 1080 | 1310 | 1540 | 1770 | 2000 | 2230 | 2470 | 2700 | 2930 | 3160 | 3390 | 3620 | 3860 | 4090 |
| HK mm | 1000 | 1251 | 1501 | 1751 | 2001 | 2251 | 2501 | 2751 | 3001 | 3251 | 3501 | 3751 | 4001 | 4251 |
|       | 1250 | 1500 | 1750 | 2000 | 2250 | 2500 | 2750 | 3000 | 3250 | 3500 | 3750 | 4000 | 4250 | 4500 |

70 STD  
70 BLOCK

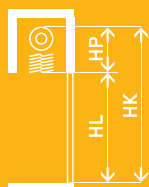

|       |      |      |      |      |      |      |      |      |      |      |      |      |
|-------|------|------|------|------|------|------|------|------|------|------|------|------|
| HP mm | 180  | 200  | 220  | 230  | 250  | 270  | 290  | 300  | 320  | 340  | 360  | 380  |
| HL mm | 820  | 1051 | 1281 | 1521 | 1751 | 1981 | 2211 | 2451 | 2681 | 2911 | 3141 | 3371 |
|       | 1070 | 1300 | 1530 | 1770 | 2000 | 2230 | 2460 | 2700 | 2930 | 3160 | 3390 | 3620 |
| HK mm | 1000 | 1251 | 1501 | 1751 | 2001 | 2251 | 2501 | 2751 | 3001 | 3251 | 3501 | 3751 |
|       | 1250 | 1500 | 1750 | 2000 | 2250 | 2500 | 2750 | 3000 | 3250 | 3500 | 3750 | 4000 |

65 STD  
65 CC/SN  
65 ECO

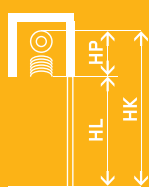

|       |      |      |      |      |      |      |      |      |      |      |      |      |      |      |
|-------|------|------|------|------|------|------|------|------|------|------|------|------|------|------|
| HP mm | 160  | 180  | 200  | 210  | 230  | 250  | 270  | 290  | 320  | 330  | 340  | 360  | 380  | 390  |
| HL mm | 840  | 1071 | 1301 | 1541 | 1771 | 2001 | 2231 | 2461 | 2681 | 2921 | 3161 | 3391 | 3621 | 3861 |
|       | 1090 | 1320 | 1550 | 1790 | 2020 | 2250 | 2480 | 2710 | 2930 | 3170 | 3410 | 3640 | 3870 | 4110 |
| HK mm | 1000 | 1251 | 1501 | 1751 | 2001 | 2251 | 2501 | 2751 | 3001 | 3251 | 3501 | 3751 | 4001 | 4251 |
|       | 1250 | 1500 | 1750 | 2000 | 2250 | 2500 | 2750 | 3000 | 3250 | 3500 | 3750 | 4000 | 4250 | 4500 |

81 P

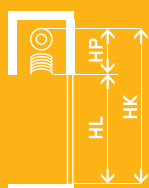

|       |      |      |      |      |      |      |      |      |      |      |      |
|-------|------|------|------|------|------|------|------|------|------|------|------|
| HP mm | 150  | 155  | 160  | 165  | 170  | 175  | 180  | 185  | 190  | 195  | 200  |
| HL mm | 500  | 1510 | 1760 | 2010 | 2260 | 2510 | 2760 | 3010 | 3260 | 3510 | 3760 |
|       | 1500 | 1750 | 2000 | 2250 | 2500 | 2750 | 3000 | 3250 | 3500 | 3750 | 4000 |
| HK mm | 650  | 1665 | 1920 | 2175 | 2430 | 2685 | 2940 | 3195 | 3450 | 3705 | 3960 |
|       | 1650 | 1905 | 2160 | 2415 | 2670 | 2925 | 3180 | 3435 | 3690 | 3945 | 4200 |



**LUPAK**  
**METAL®**



**LUPAK  
METAL®**

**LUPAK METAL srl**  
48018 Faenza RA ITALIA  
T +39 0546.646140  
F +39 0546.46317  
[www.lupakmetal.com](http://www.lupakmetal.com)

---